



Item # _____
 Project : _____
 Qty : _____

5 Tube Fryers

Model No.

SGF-70N / SGF-70L



SGF-70

Features:

- 30,000 BTU per tube and thermostat with a temperature range of 200°F to 400°F
- Stainless steel front, top & header; sides & back galvanized steel
- Stainless steel door with integral liner & recessed handle
- Stainless steel fry tank with peened finish; cold zone in fry tank
- Double-rod stainless steel basket hanger
- 1-1/4" full-port drain valve for easy cleaning
- All fryers have drain tube racks and wire mesh fry baskets
- 6" stainless steel legs with 1" adjustability
- Optional Casters Available (5SB-3535)

Warranty Info:

One Year

- Parts & Labor on entire unit.
- Valid in United States.
- Valid for commercial use only.

Two Year

- Pot, Part Only.



Conforms to UL471, CSA C22.2 and NSF 7 Standards.

Revised 04/18/2024

SGF-70

Phone:(800).768.5953
 Fax:(800).976.1299

www.servware.com
 Copyright © 2024 Serv-Ware Products LLC.

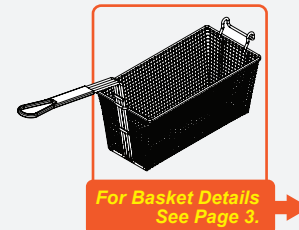
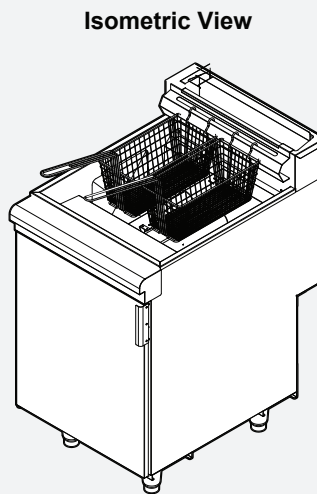
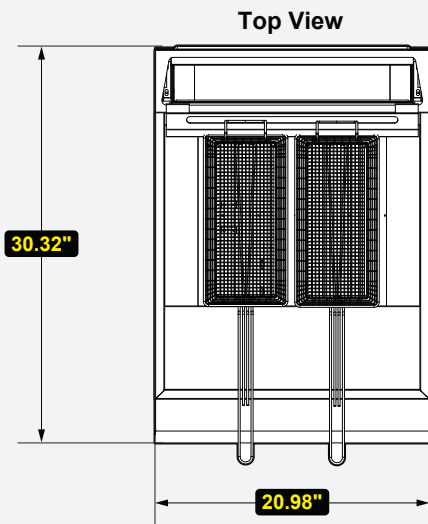
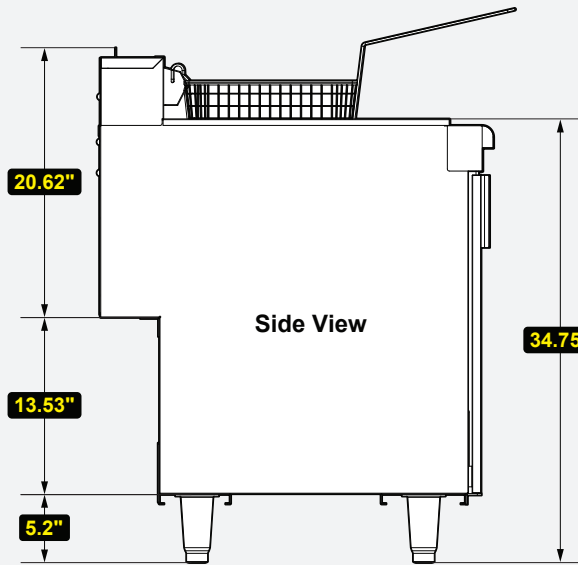
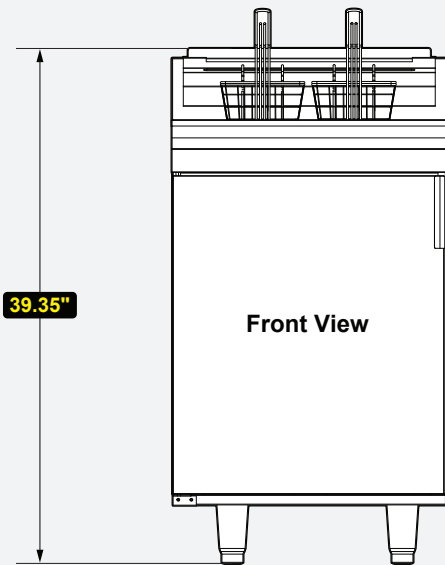

➤ Technical Information:

MODEL #	DESCRIPTION	DIMENSIONS	WEIGHT/LBS.
		(W x D x H)	(Shipping)
SGF-70N	5 Tube Natural, 70 lbs.	21" W x 30.2" D x 46.5" H	205 lbs.
SGF-70L	5 Tube LP, 70 lbs.	21" W x 30.2" D x 46.5" H	205 lbs.

CONSTRUCTION
Stainless steel front, top & header; sides & back galvanized steel. Stainless steel legs & door with integral liner & recessed handle. Stainless steel fry tank with peened finish. Double-rod stainless steel basket hanger with wire mesh fry baskets.

COOKING	
Temperature Range	200°F – 400°F
BTU/H per Burner	30,000
Gas Inlet	½ in.
Required Gas Hose	¾
W.C. for Natural Gas	4 in.
W.C. for LP	10 in.

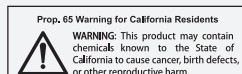

Front View

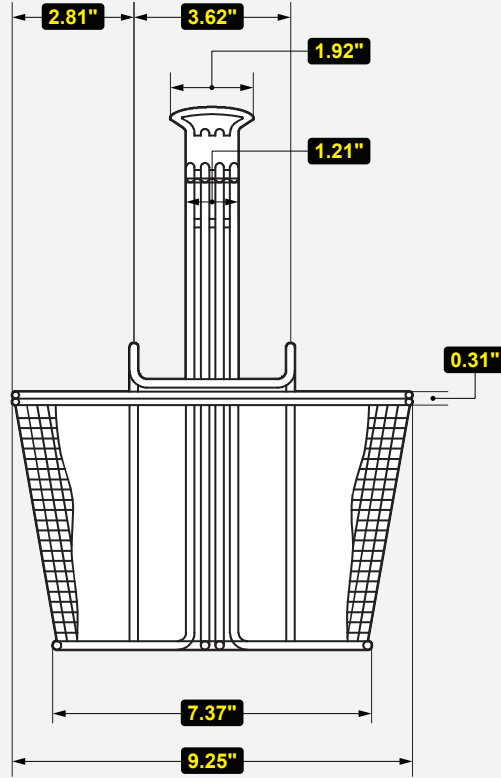

Side View

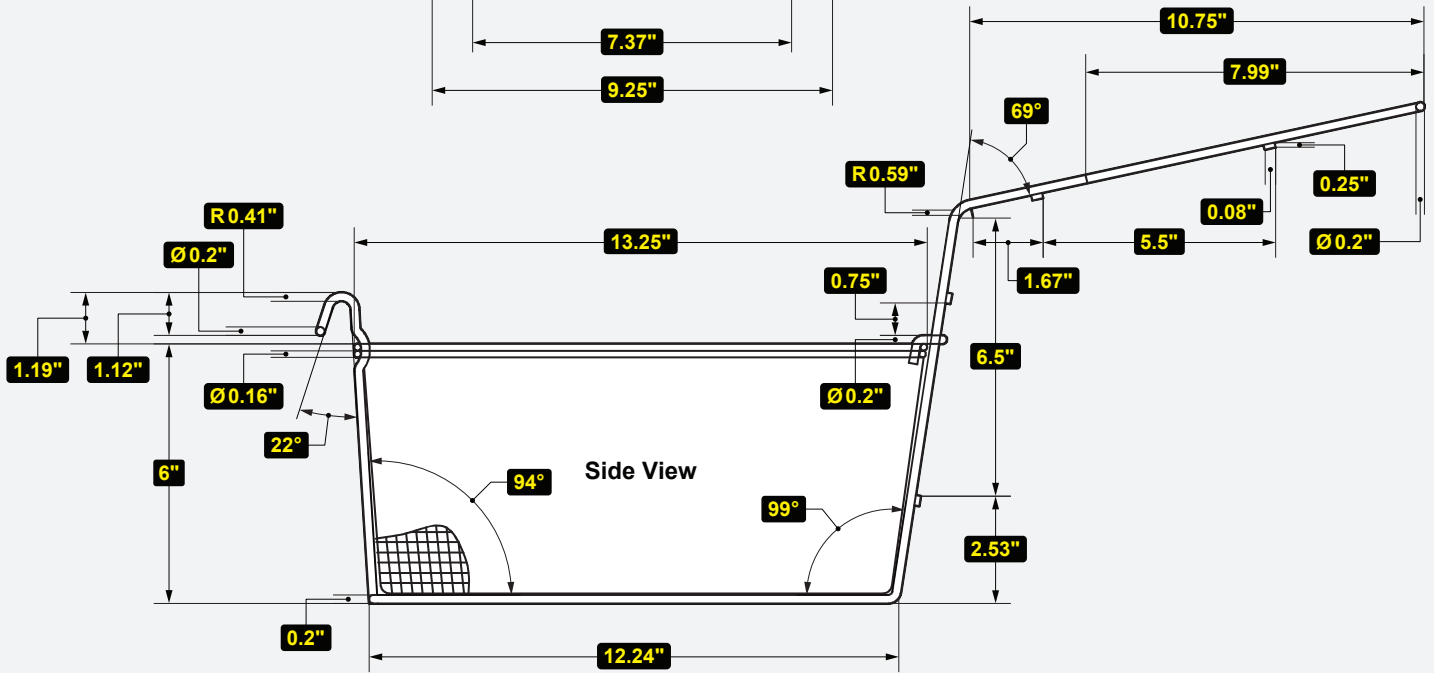

Top View

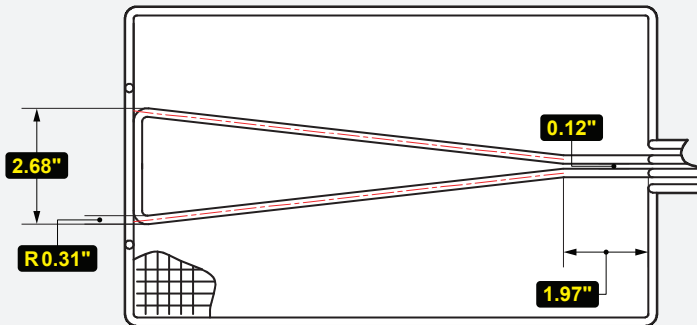

SGF Series - Gas Fryers

Notify carrier of damage! Inspect all components immediately.

Serv-Ware Products warrants to the original owner/user that any piece of gas cooking equipment manufactured shall be free of defects in material or workmanship, under normal use and maintenance, for a period of one (1) year from the original installation date or a maximum of eighteen (18) months after the shipment date from Serv-Ware Products. Proper installation and start-up in accordance with the instruction manual supplied will be taken into consideration when evaluating the warranty on the specified equipment. Labor warranty charges are valid in the United States only.

The labor warranty shall include standard labor charges at the product location only. The end user is responsible for any emergency, overtime, or long-distance travel charges. Any labor service required to fulfill the warranty obligation must be performed by a qualified gas appliance service company and accepted by Serv-Ware Products. Billing will be handled between the service company and manufacturer directly, there will be no compensation for charges not billed to Serv-Ware Products by the service company. Serv-Ware Products reserves the right to have any warranty "failed" parts returned to the factory for inspection before agreeing to covering the above stated warranty labor charges

This warranty does not include parts & labor coverage resulting from:

- External electrical power failure or improper supply voltage to product.
- Adverse operating conditions for the product.
- Failure to clean and/or maintain the product.
- Standard wear & tear items.
- Failure to maintain a proper gas supply pressure.
- Improper conversion practices (natural gas to propane).
- Damage that is caused by employees or customers.
- Any part or assembly that has been altered, modified, or changed.
- Equipment usage in a residential or non-commercial setting.
- Calibration adjustments.

LIMITATION OF LIABILITY AND OTHER WARRANTIES

Serv-Ware Products assumes no liability for misuse or inadequate maintenance of the Product. In no event shall the user be entitled to recover incidental or consequential damages. Including but not limited to; damages for inconvenience, food loss, rental or replacement equipment, loss of profits, or other commercial loss.

Warranties stated above are the only warranties made in connection with the sale and distribution of the Products. ANY AND ALL OTHER EXPRESSED STATUTORY AND IMPLIED WARRANTIES APPLICABLE TO THE PRODUCT INCLUDING, WITHOUT LIMITATION, ALL IMPLIED WARRANTIES OF MERCHANTABILITY AND FITNESS FOR USE ARE EXPRESSLY DISCLAIMED. The warranty information set forth above shall be governed by and construed in accordance with the laws of the State of North Carolina and, if applicable, the laws of the United States of America. The warranty, as stated, is extended only to the original owner/user and is not assignable. Serv-Ware reserves the right to change product specifications without notice due to constant product improvement.